

# HELIO 2D

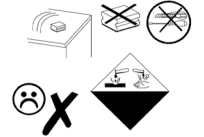

100 min

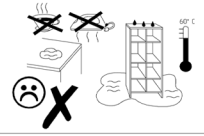
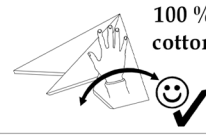
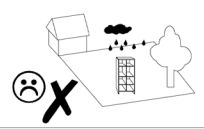
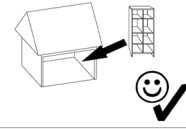
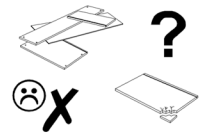
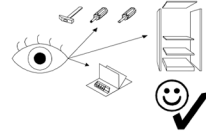
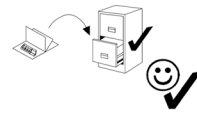
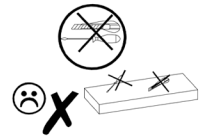
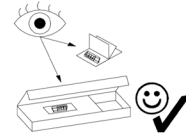
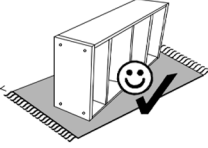
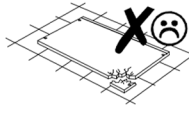
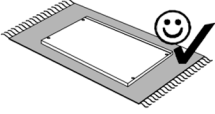
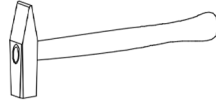
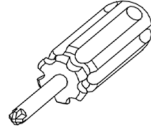
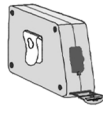
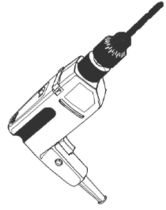

2000 mm

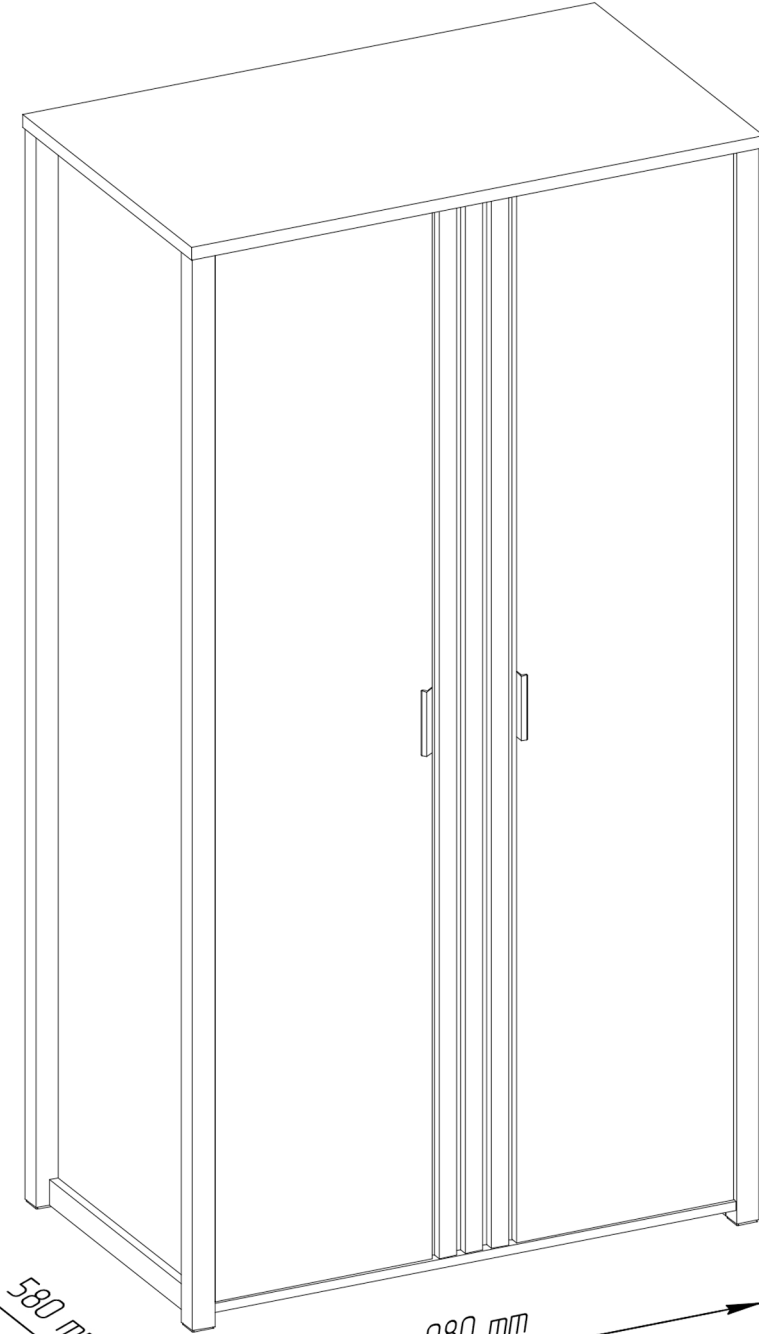

580 mm

980 mm

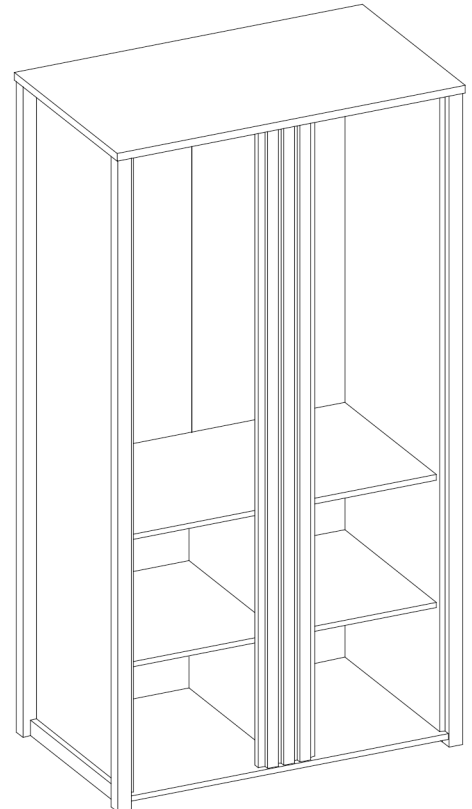

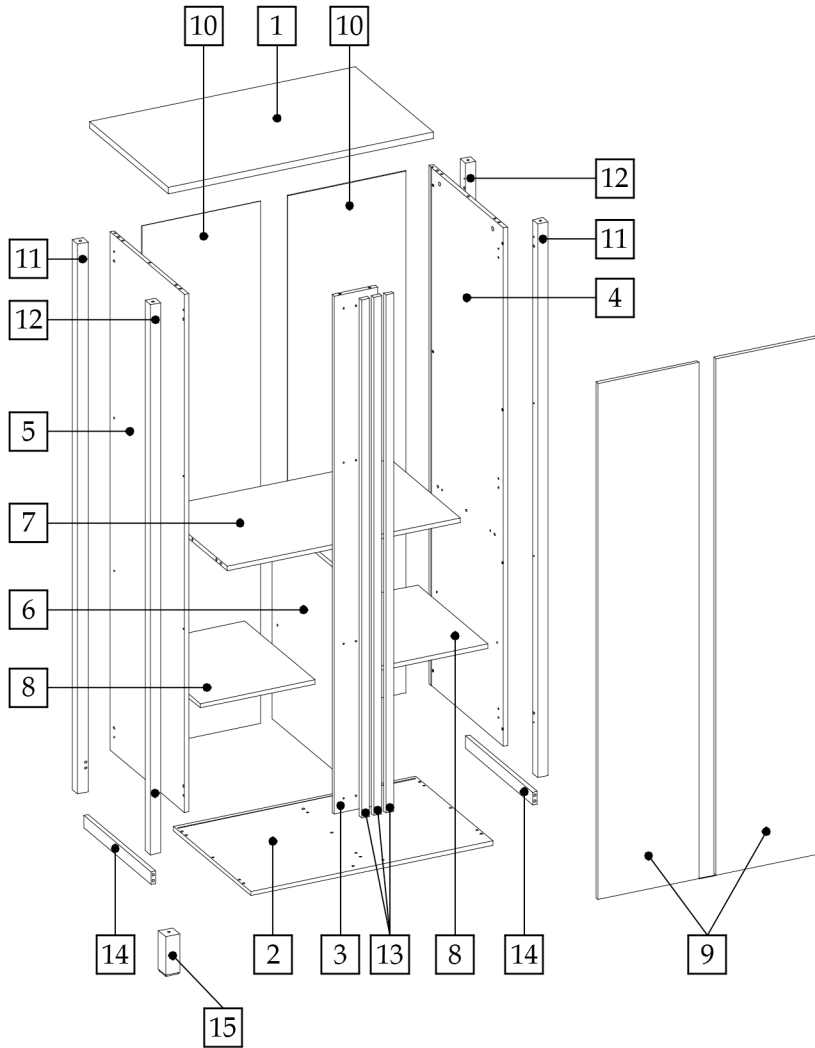
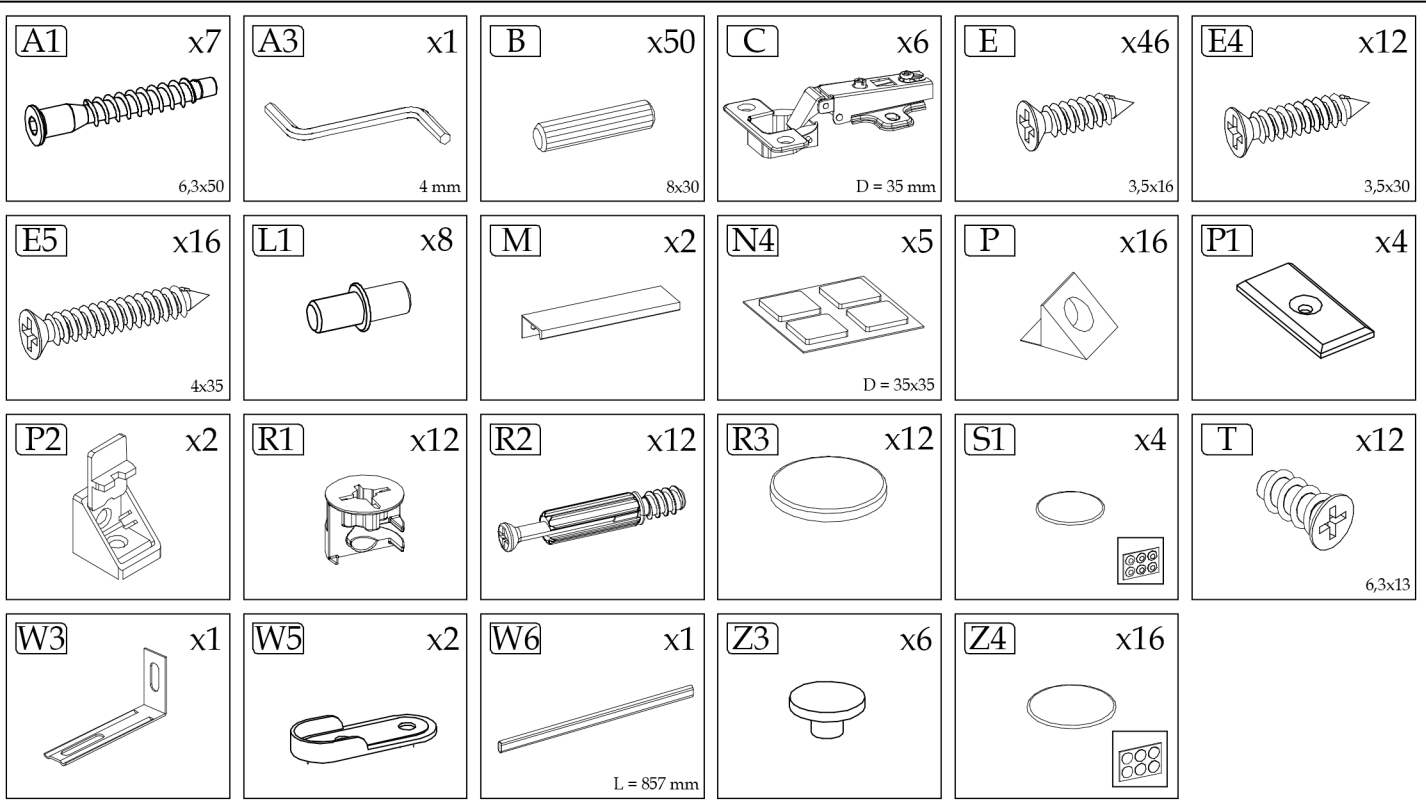

Element symbol	Measurements				Code	Pack
<b>1</b>	980	580	16	1	1001_EVOK	1/3
<b>2</b>	894	573	16	1	1013_EVOK	1/3
<b>3</b>	160	1844	16	1	1009	2/3
<b>4</b>	1844	553	16	1	1011	2/3
<b>5</b>	1844	553	16	1	1012	2/3
<b>6</b>	720	519	16	1	1016	1/3
<b>7</b>	862	518	16	1	1028	1/3
<b>8</b>	423	518	16	2	N/A	1/3
<b>9</b>	1838	372	16	2	1005/1010	2/3
<b>10</b>	1858	440	3	2	N/A	2/3
<b>11</b>	1980	38	38	2	EVOK_1980x38_T1	3/3
<b>12</b>	1980	38	38	2	EVOK_1980x38_T2	3/3
<b>13</b>	1844	30	16	3	P16_1844x30x16	2/3
<b>14</b>	499	45	16	2	P16_499x45x16	1/3
<b>15</b>	120	38	38	1	EVOK_120x38x38	1/3

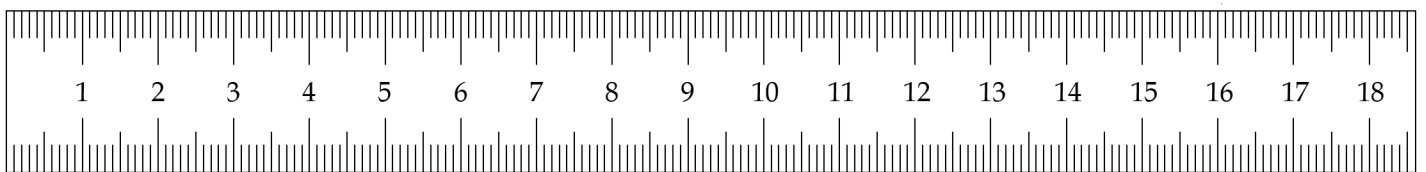
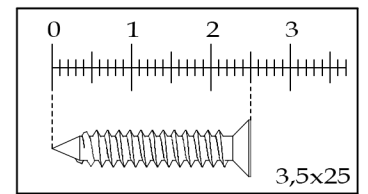

▶ 1

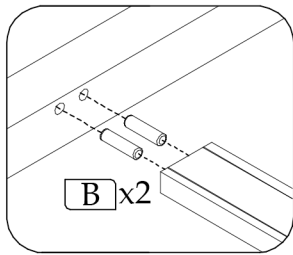

x2

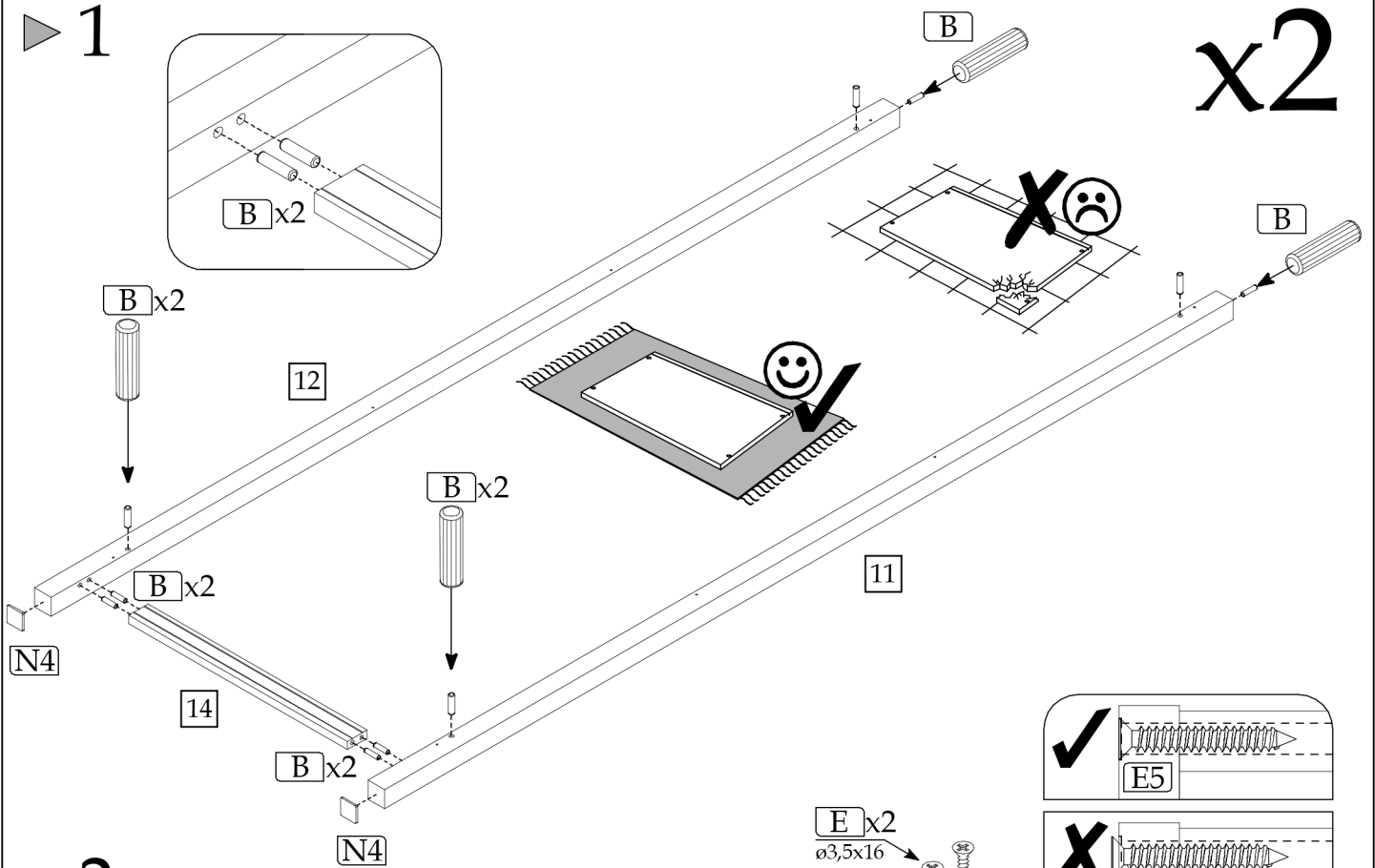

▶ 2

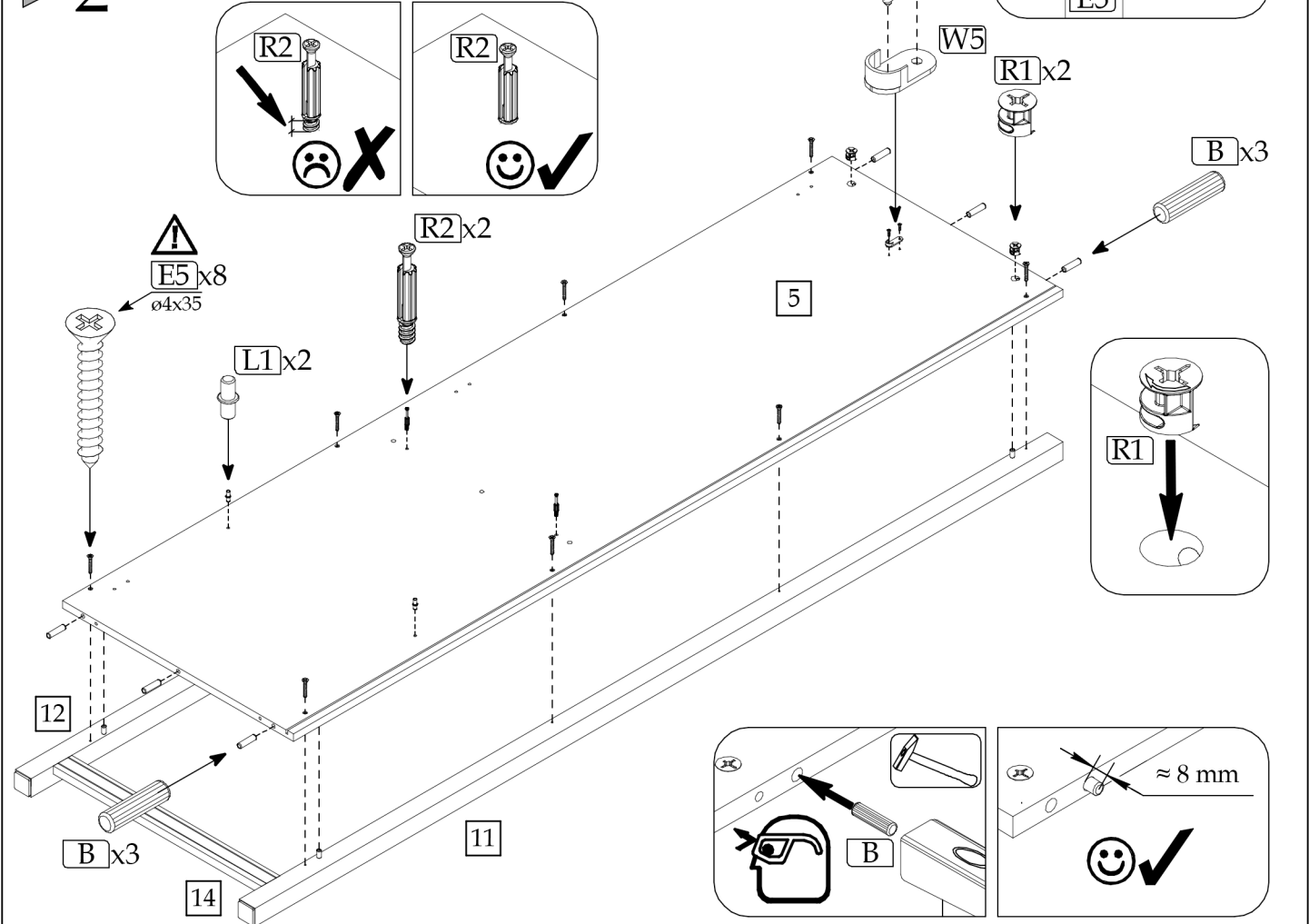
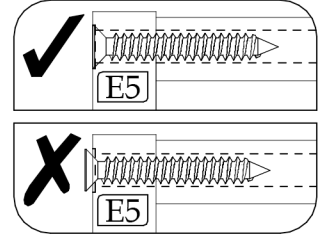
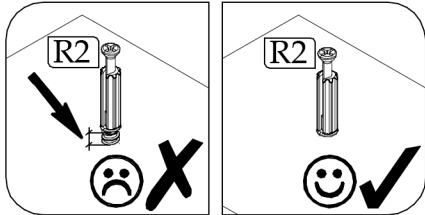

▶ 3

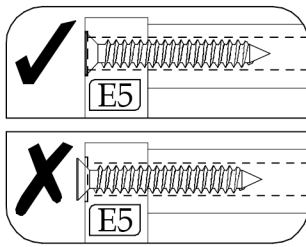

E x2  
ø3,5x16

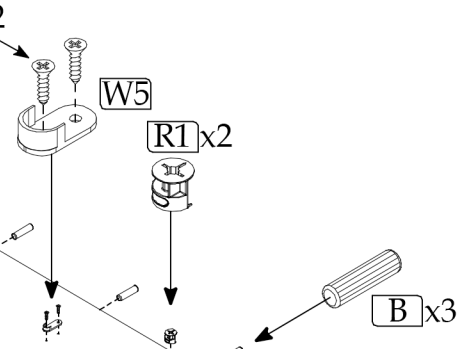

⚠  
E5 x8  
ø4x35

R2 x2

L1 x2

4

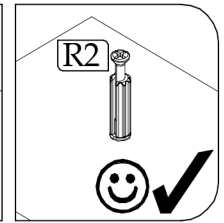
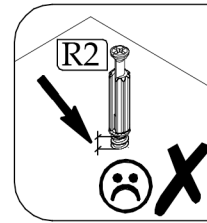
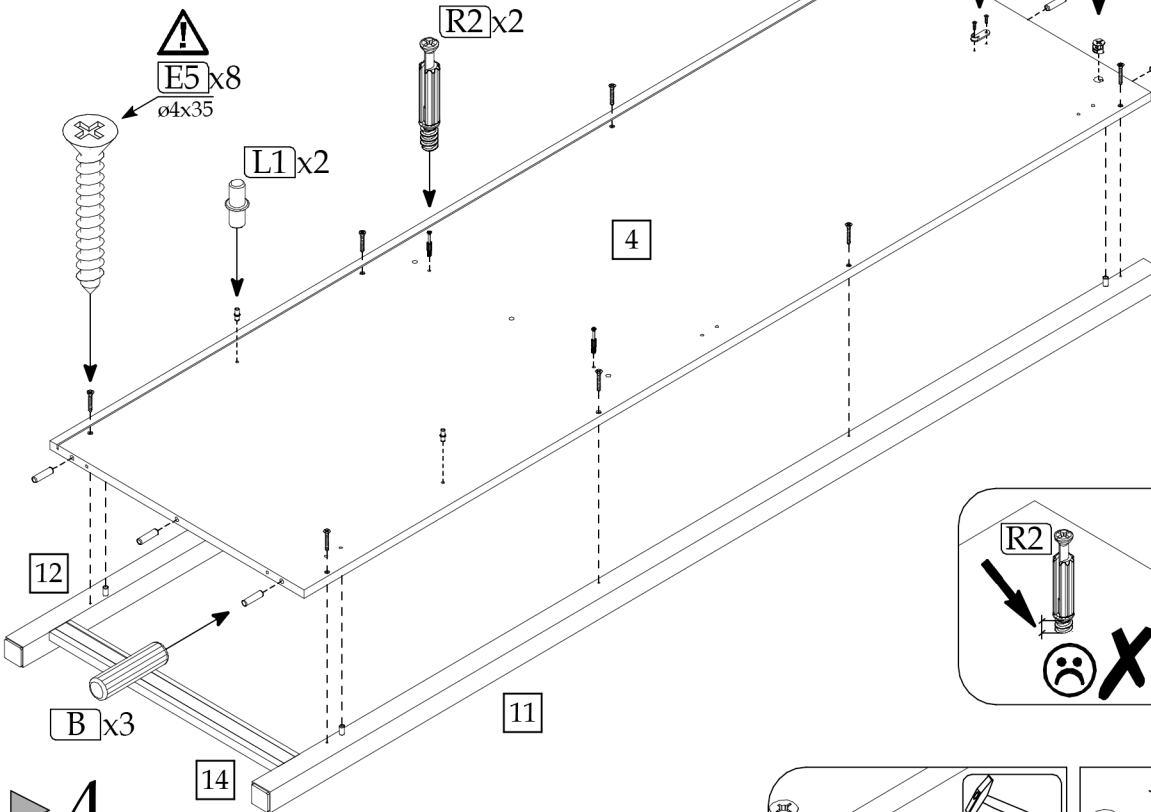
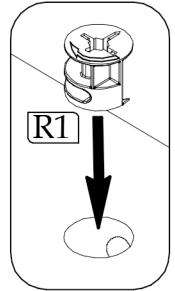

▶ 4

B x2

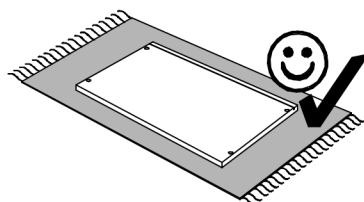
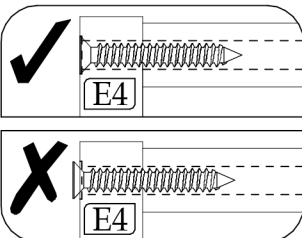
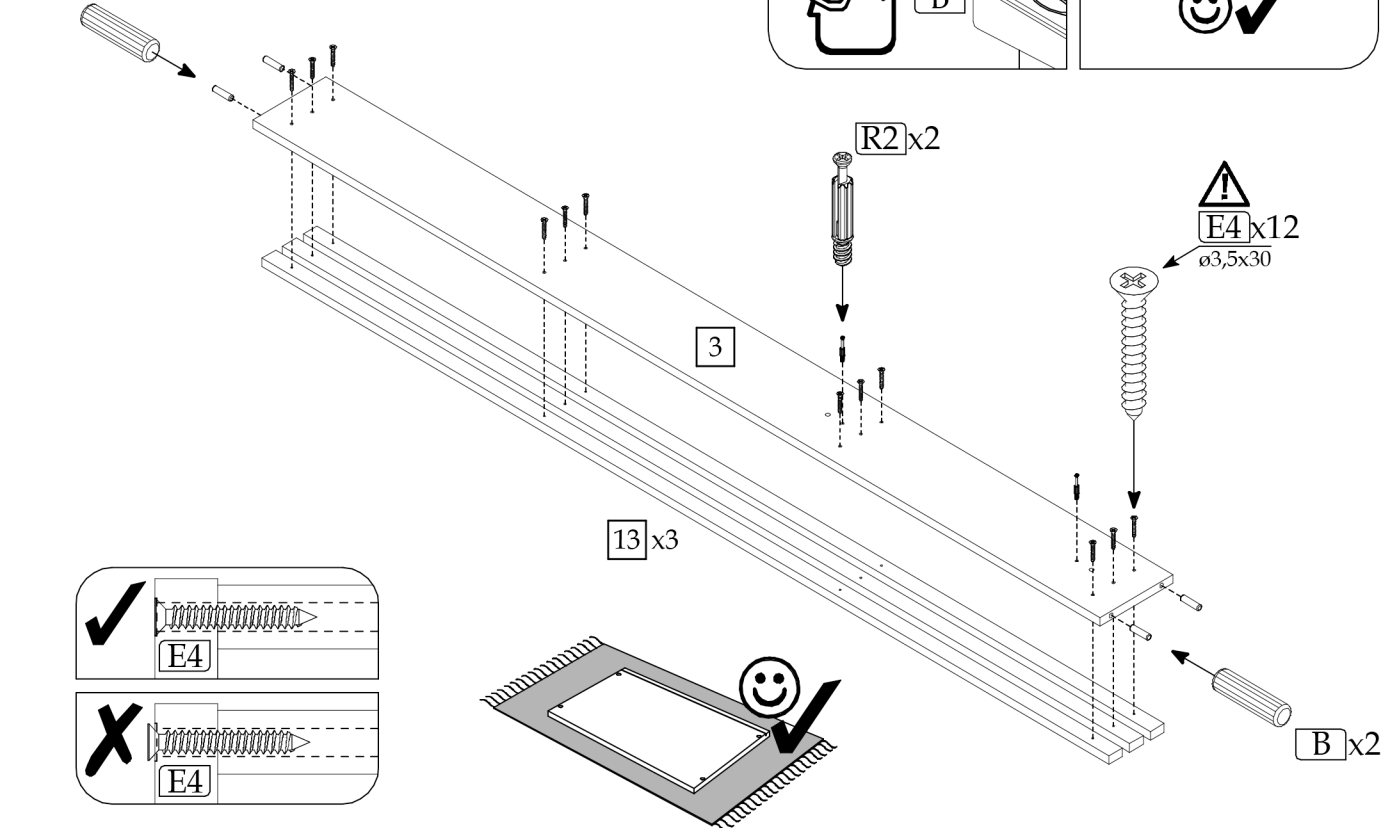
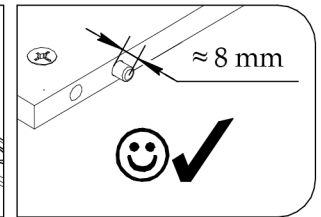
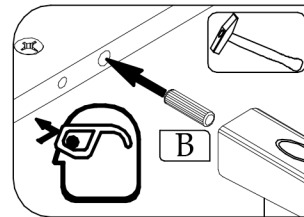

B x2



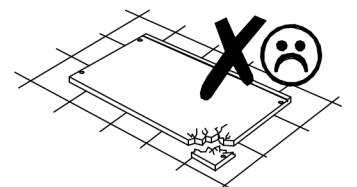
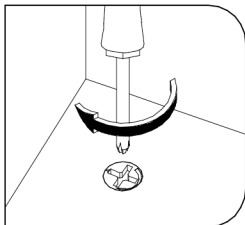
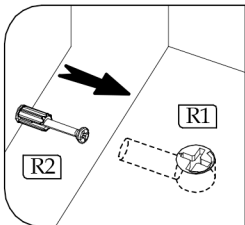
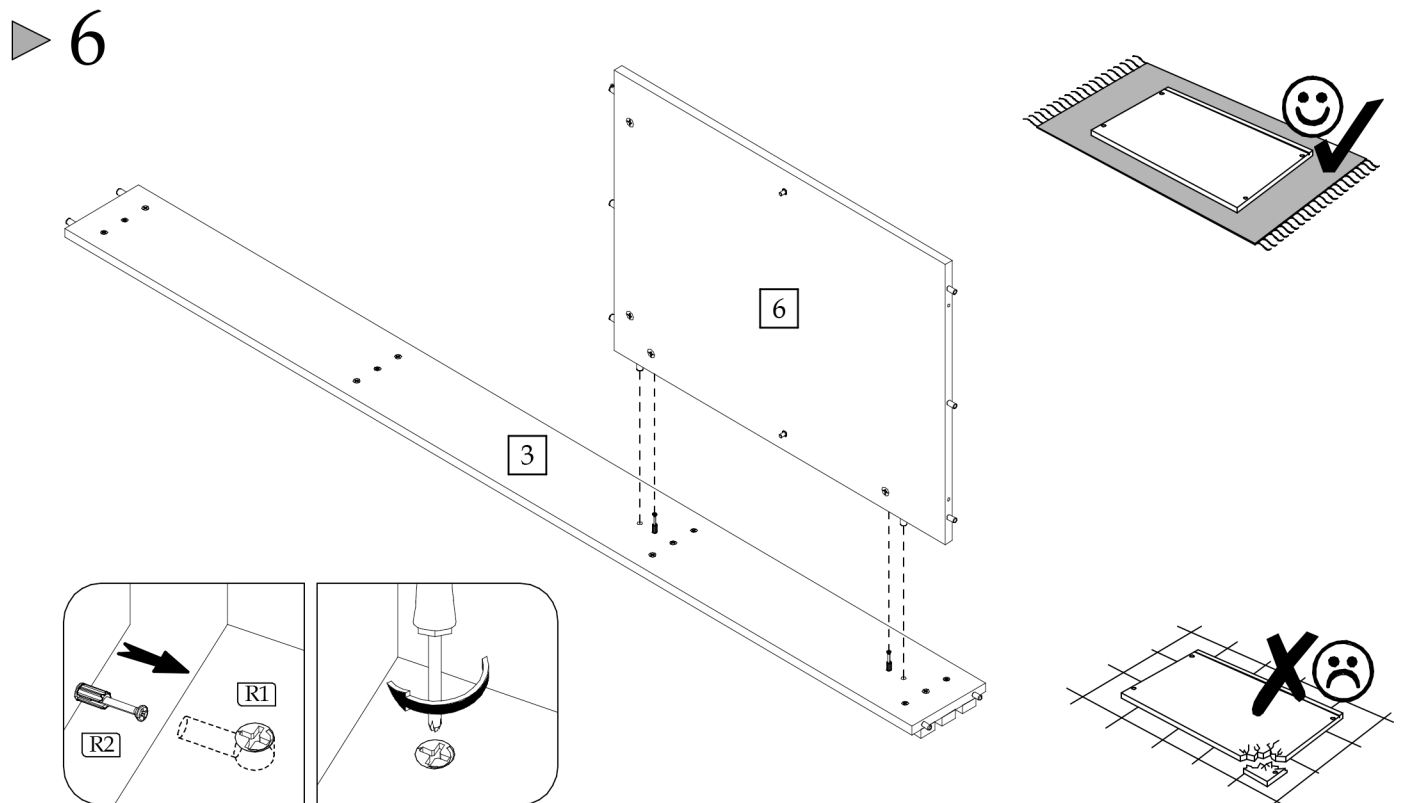
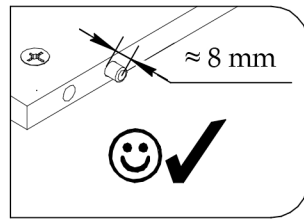
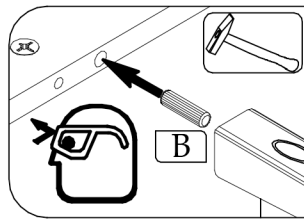
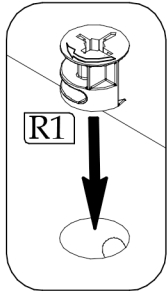
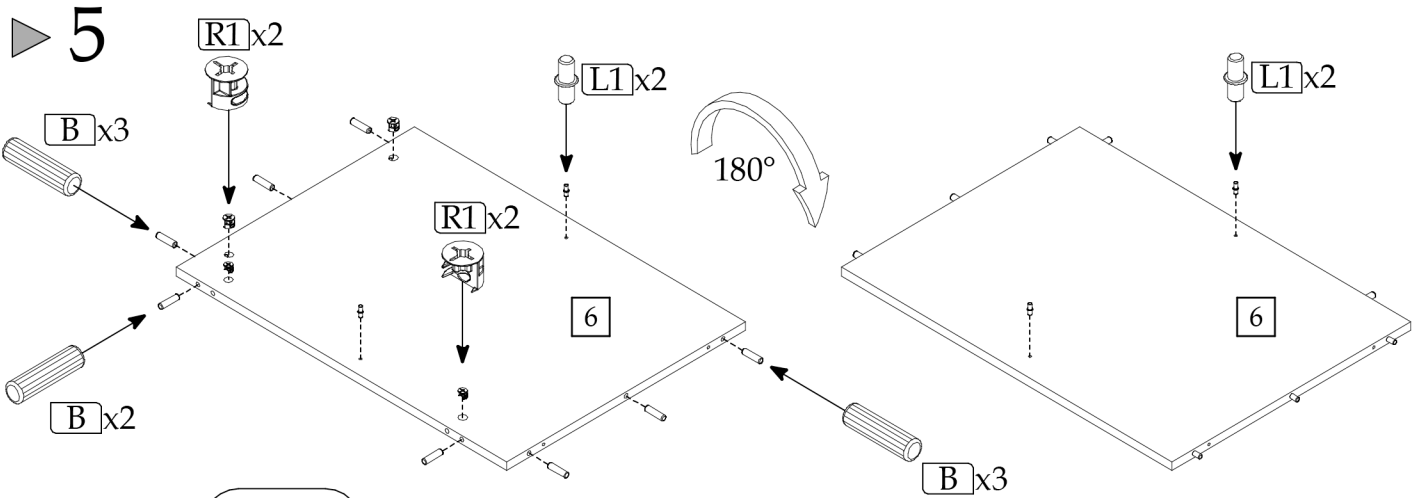
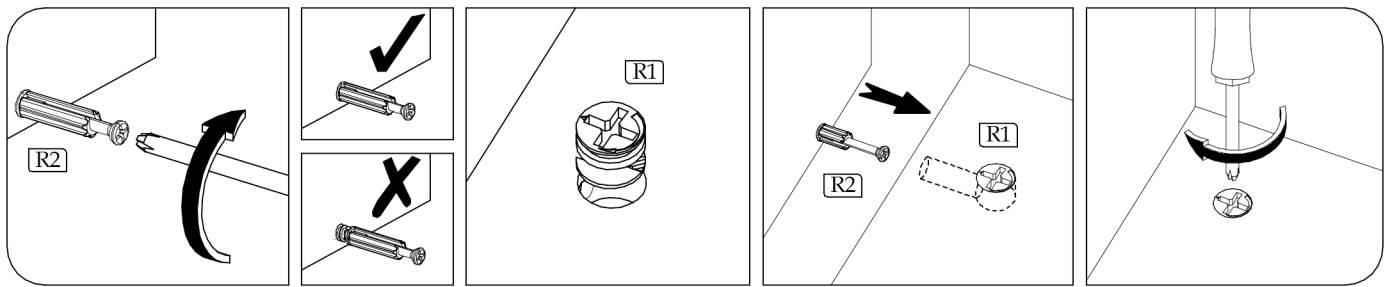

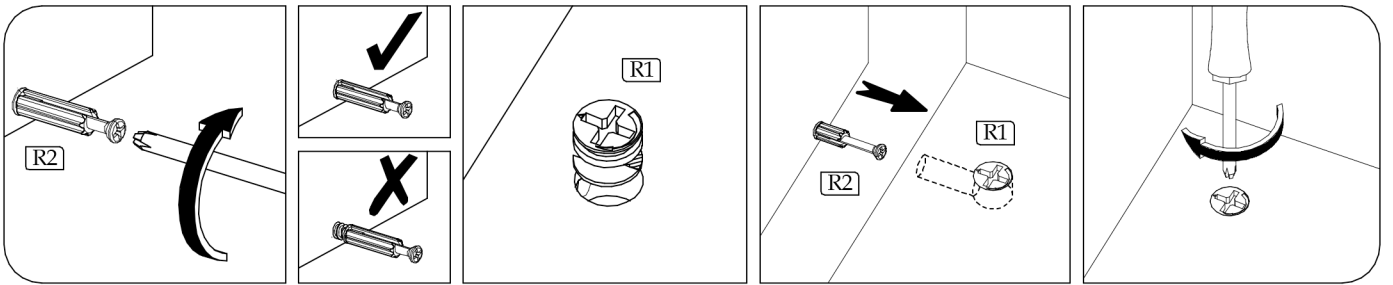

▶ 7

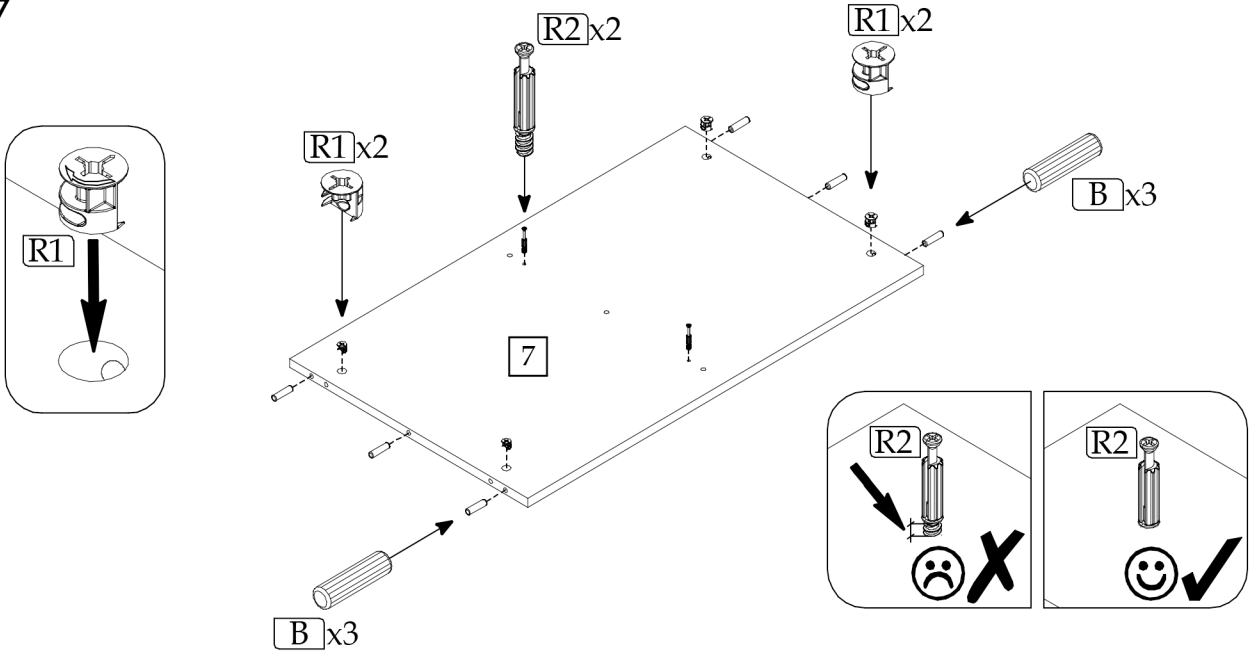

▶ 8

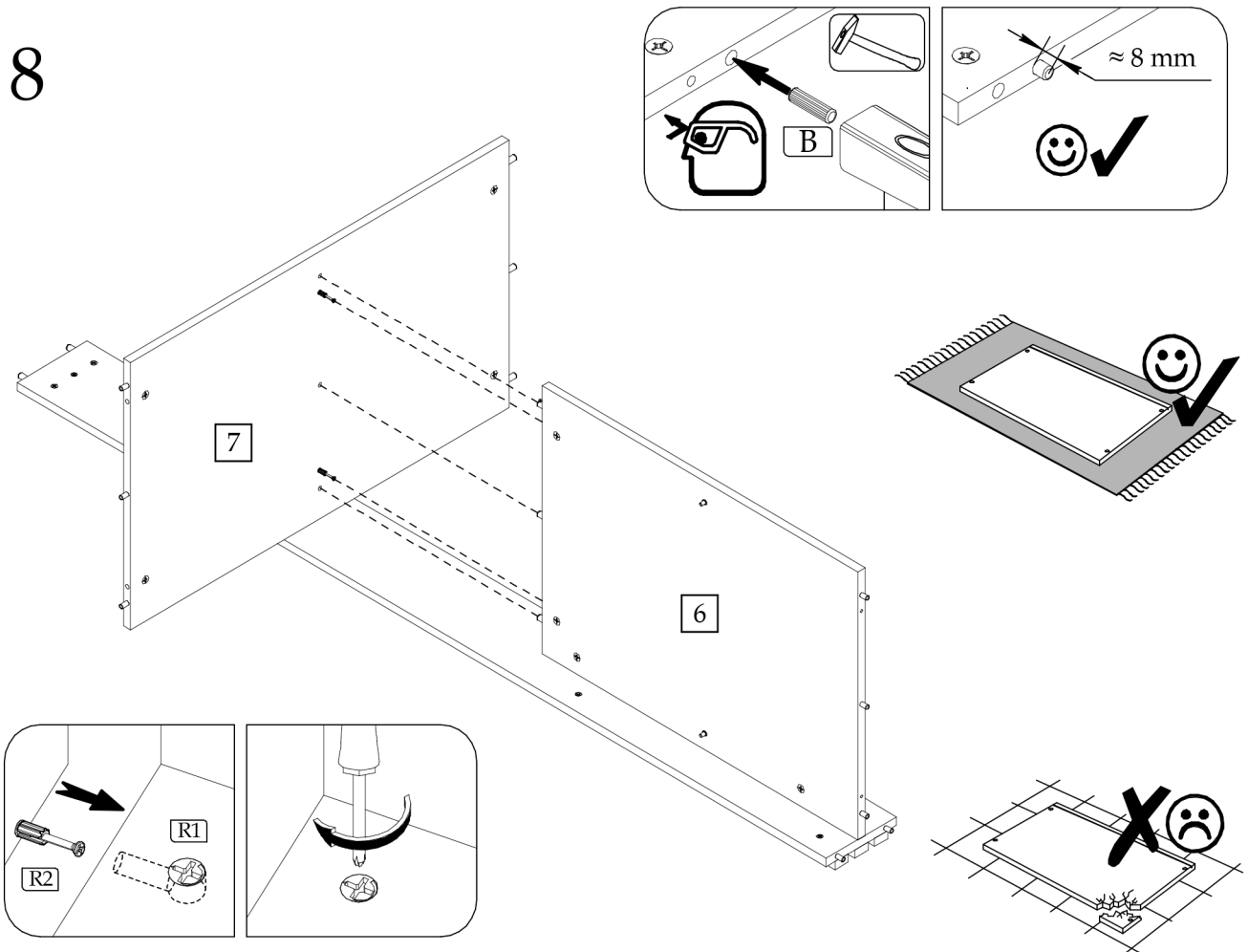

▶ 9

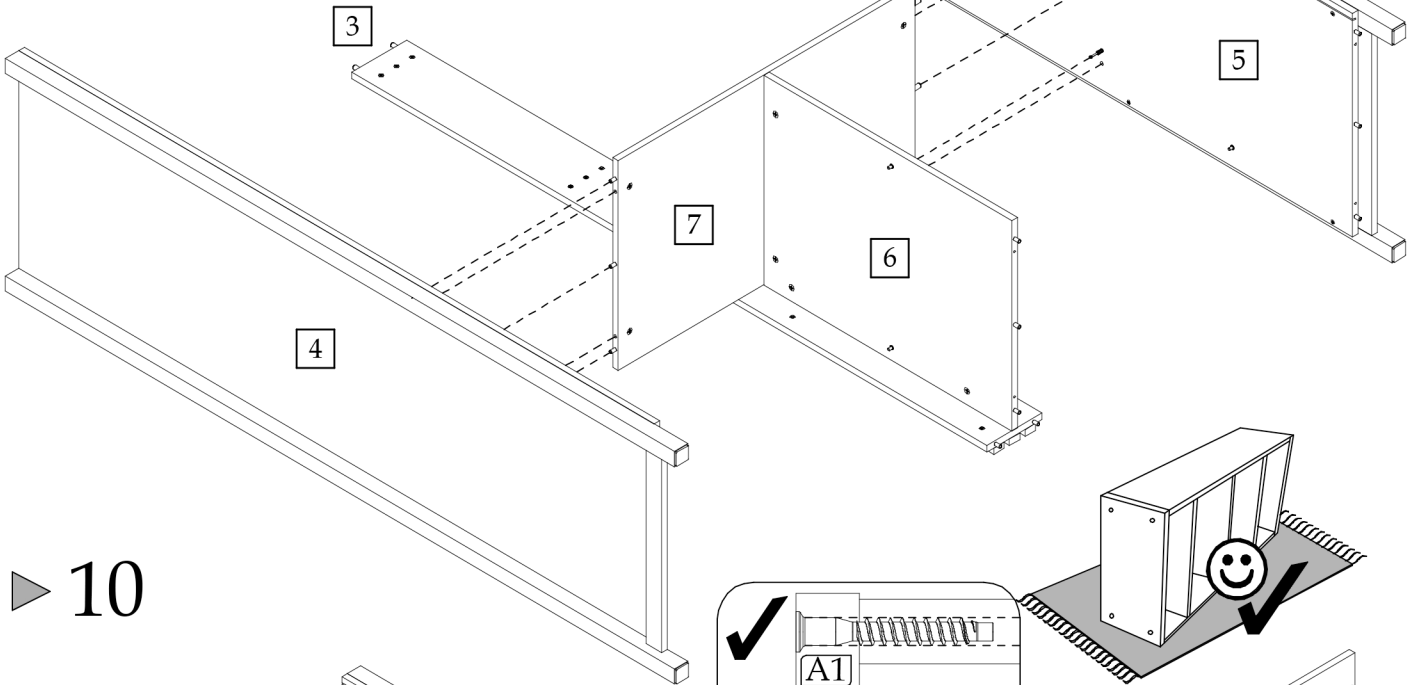
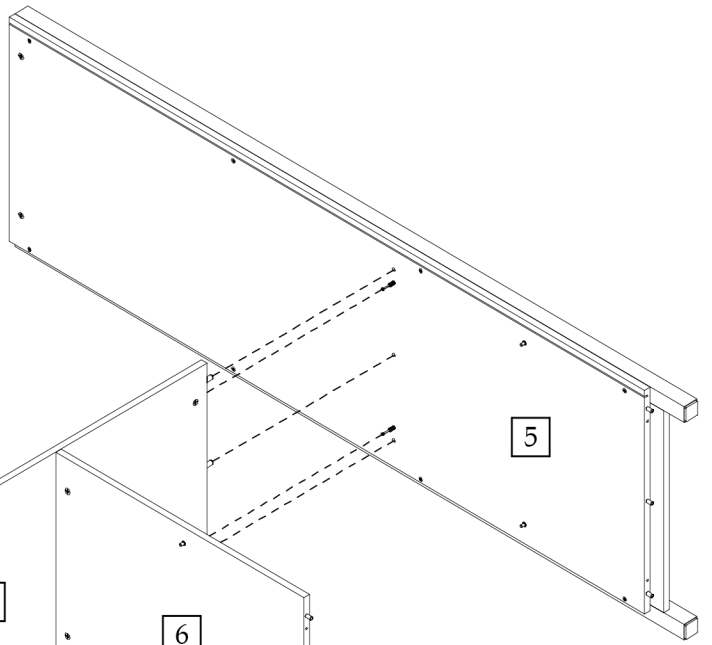
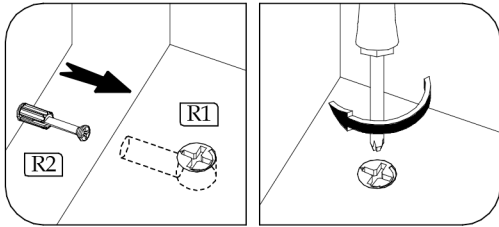

▶ 10

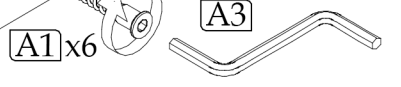
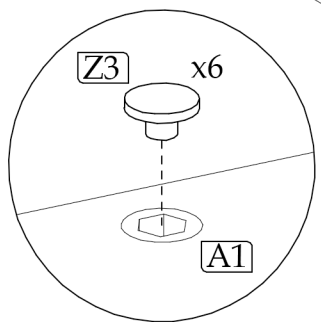
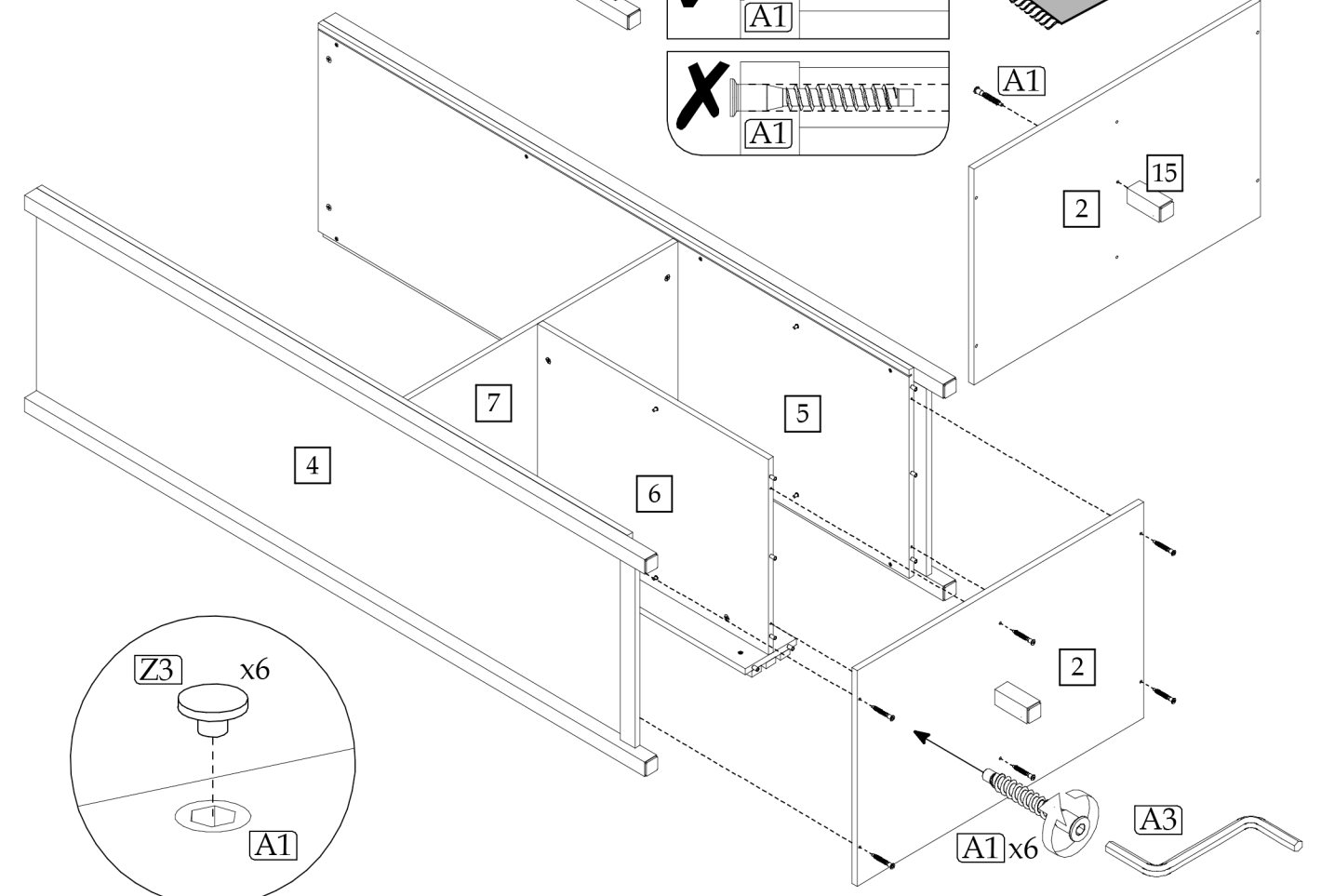
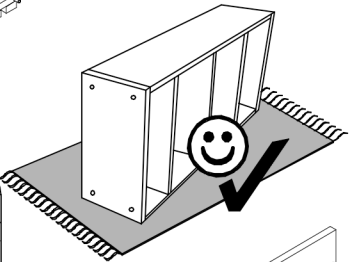
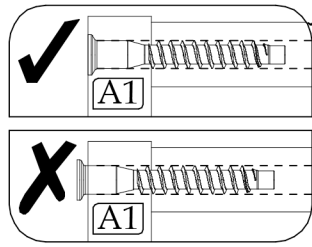

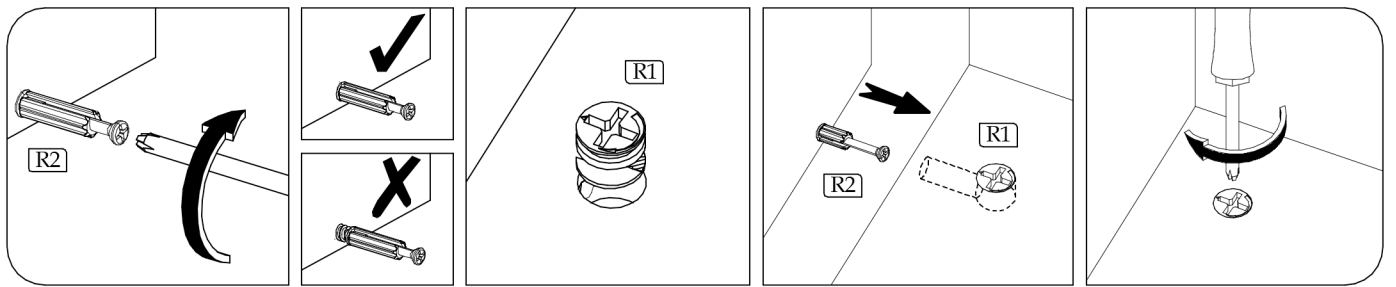

▶ 11

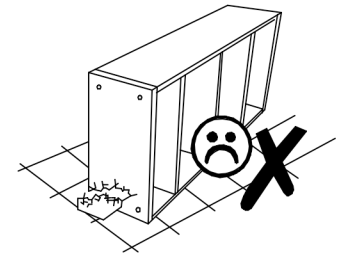
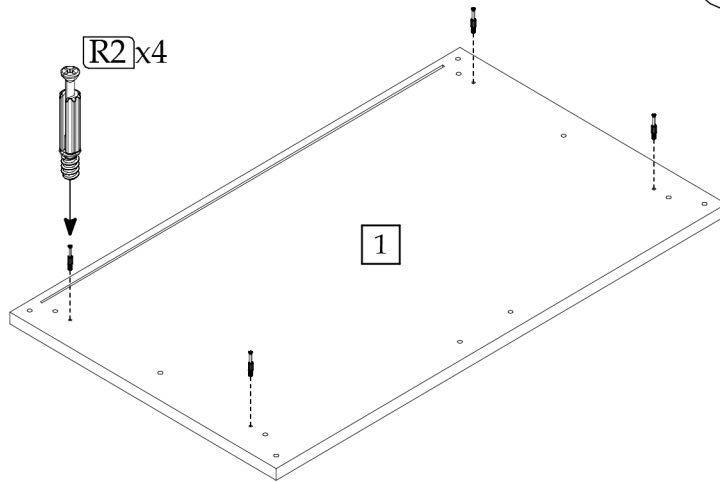
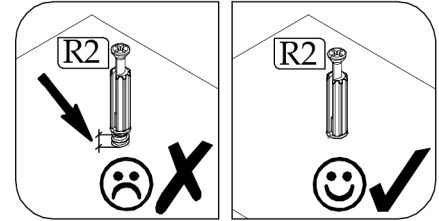
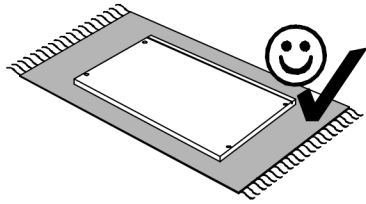

▶ 12

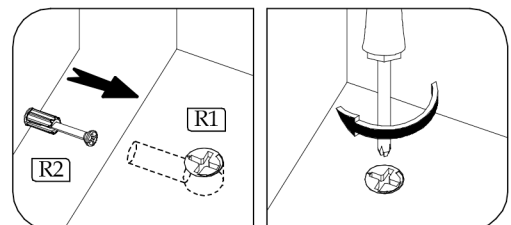
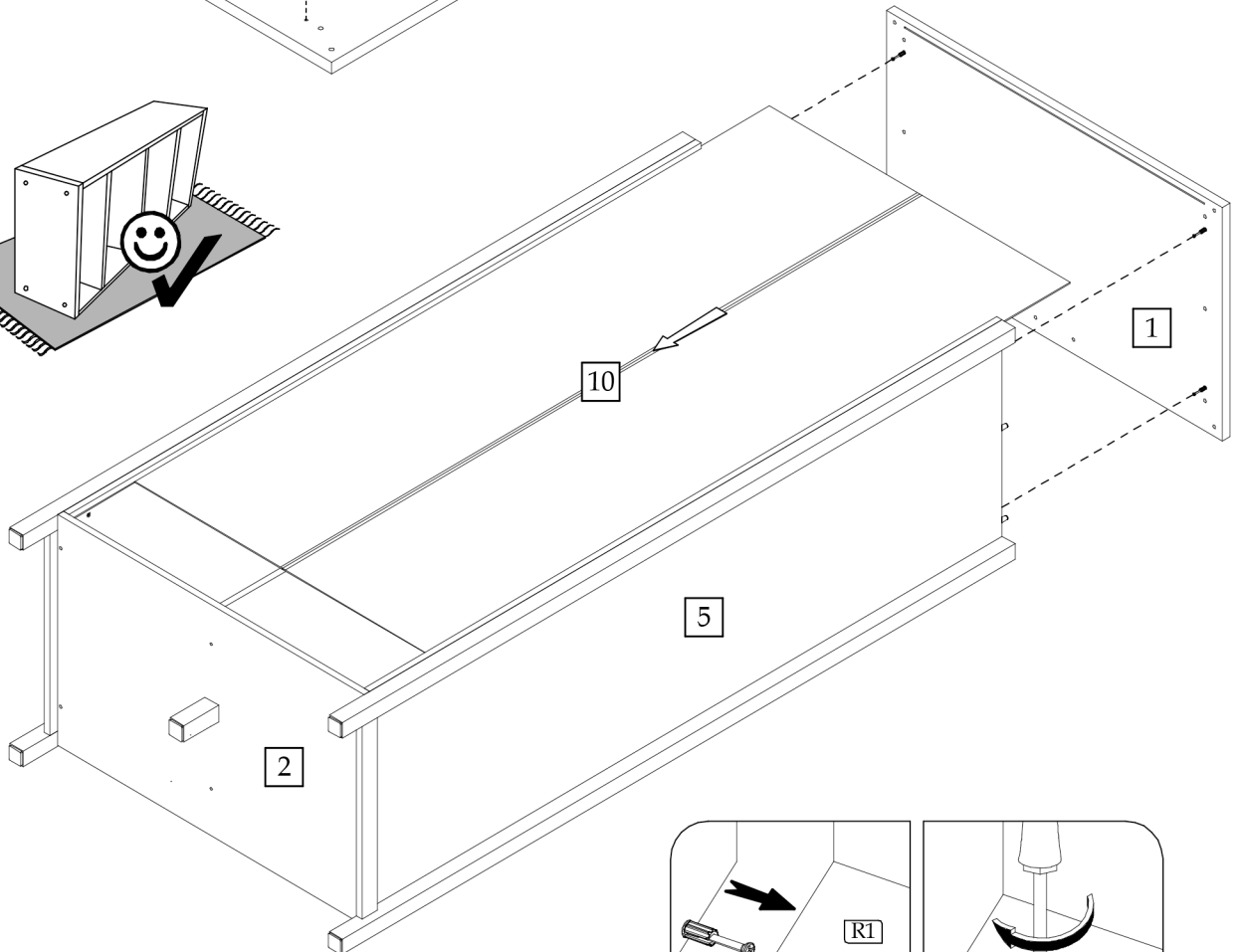
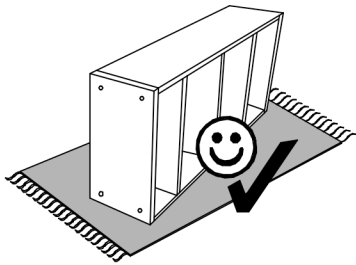

▶ 13

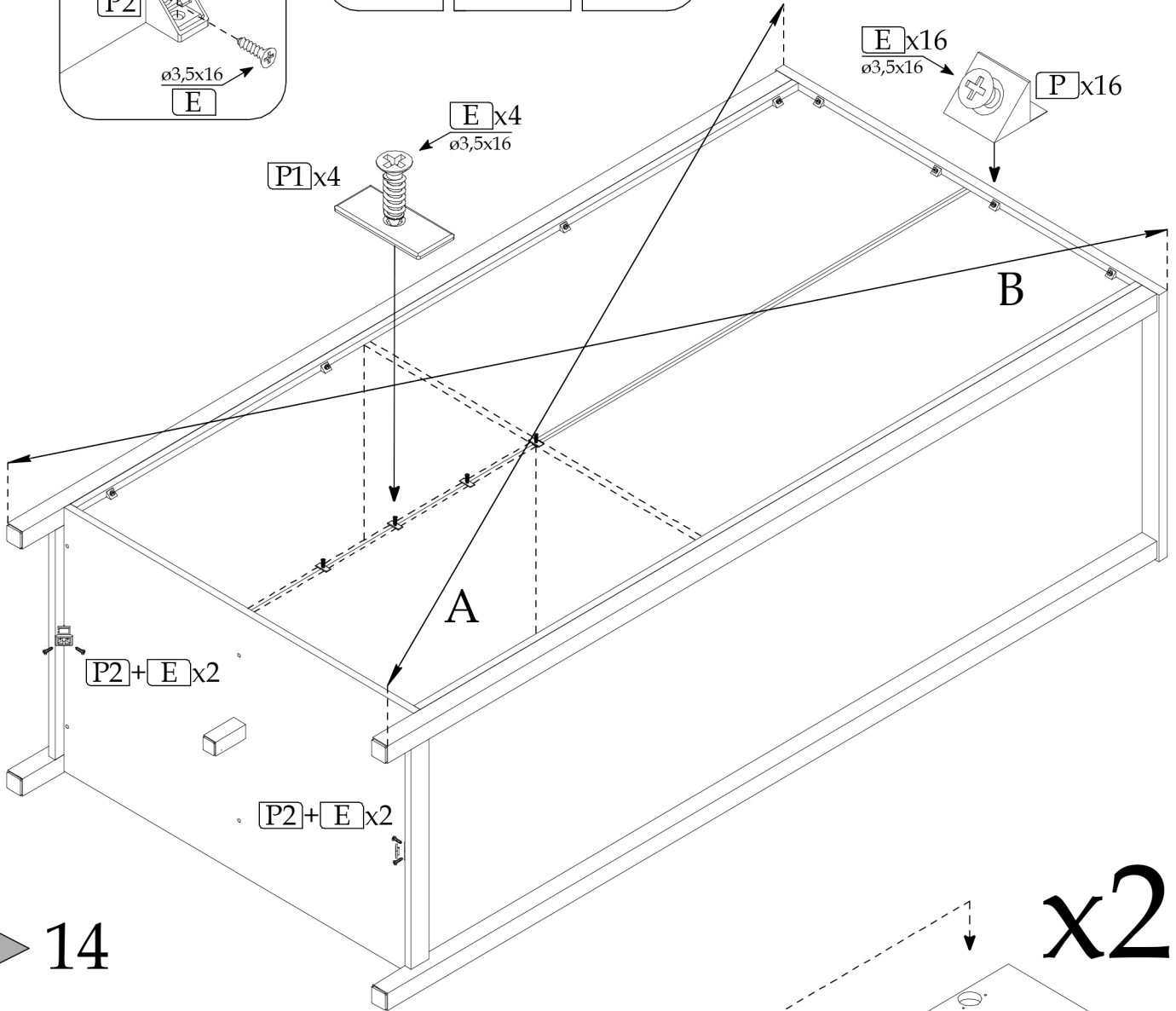
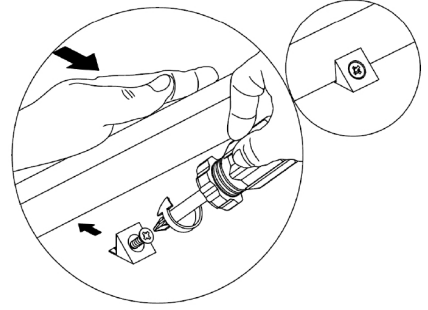
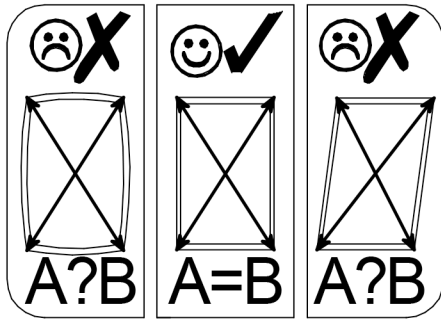
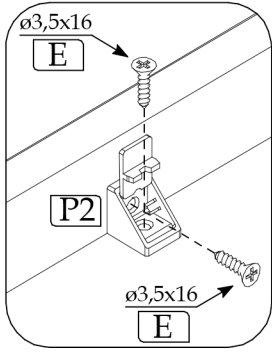

▶ 14

